

Piggy Puppet

©Shoko Aoyagi 2004

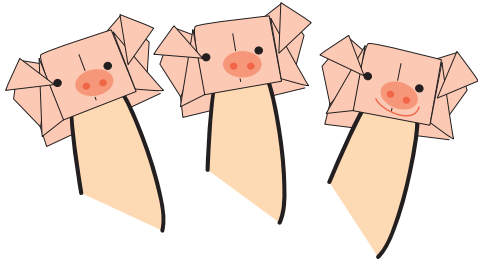

You need a sheet of origami paper and some pens to draw the face.

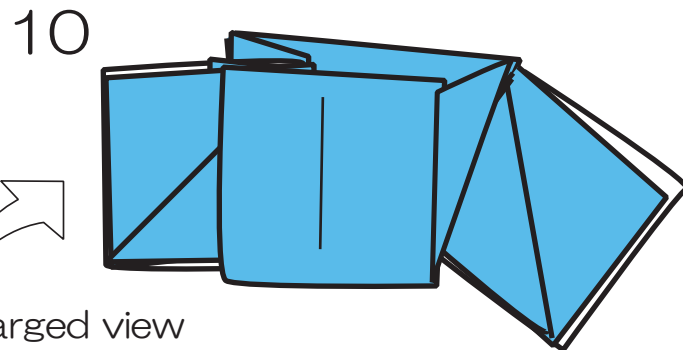
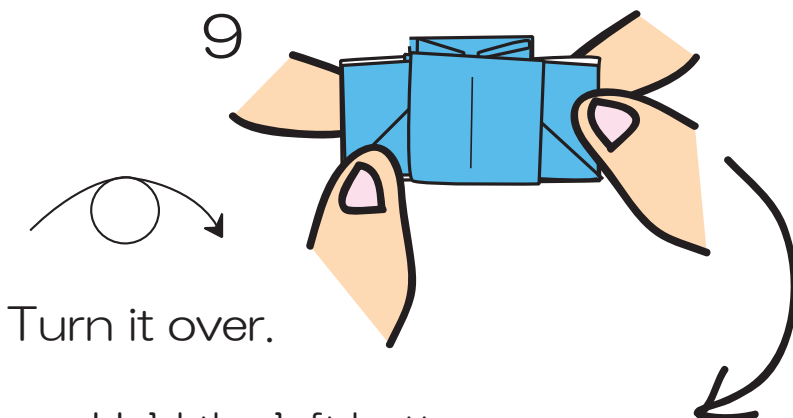
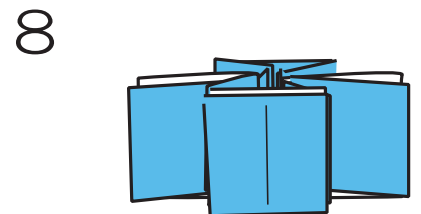
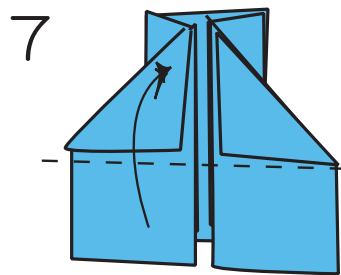
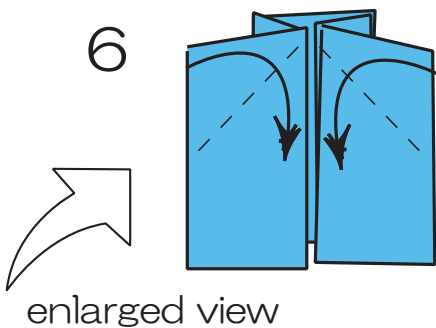
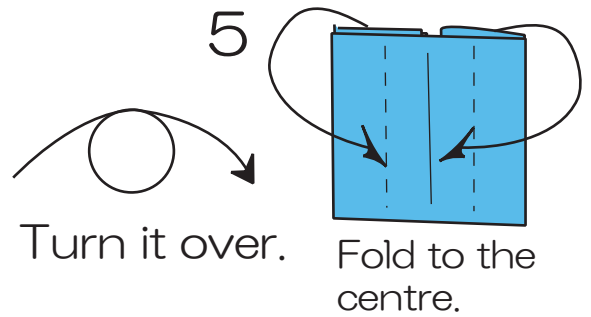
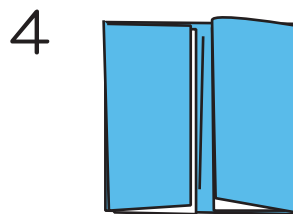
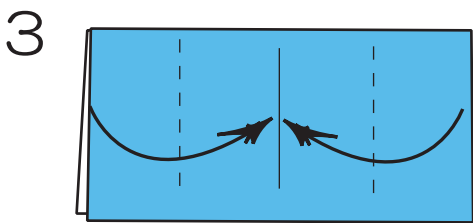
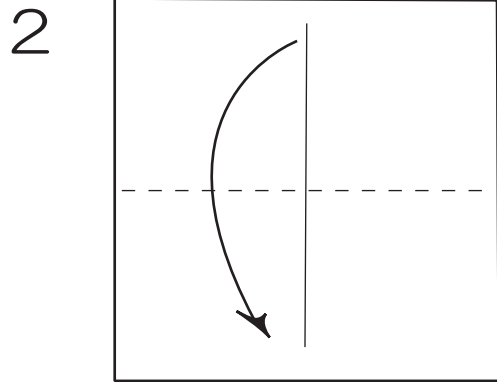
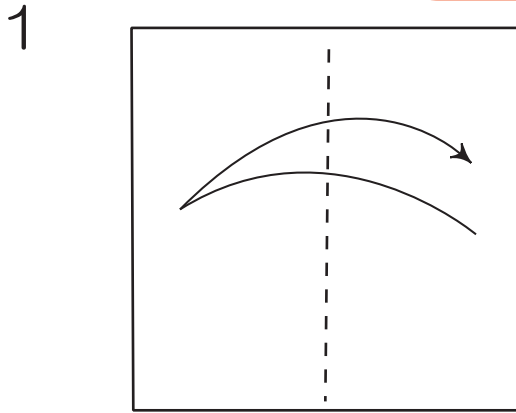

Hold the left bottom corner with your left hand, pull the right edges outwards with right hand as shown.

Piggy puppet

©Shoko Aoyagi 2004

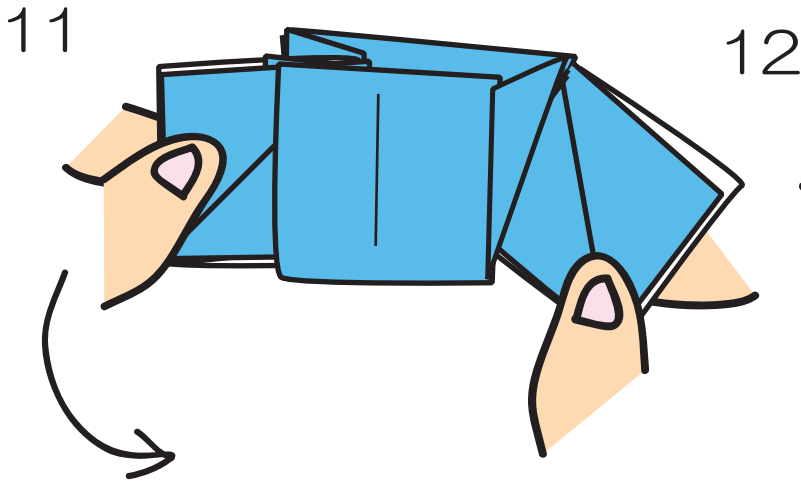

Holding the right bottom corner with your right hand, pull the left edges outwards with your left hand as shown.

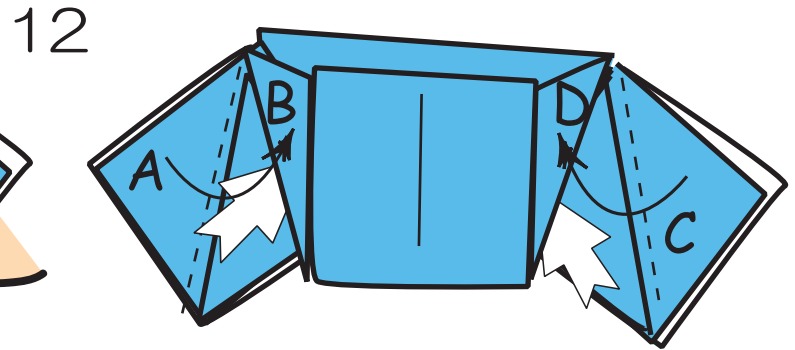

This is the result.

Tuck the triangular shaped layers 'A' under 'B'. Tuck the triangle shaped layers 'C' under 'D' as shown.

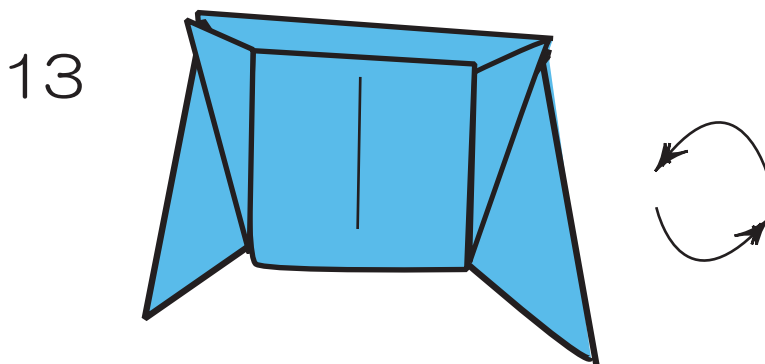

This is the result.

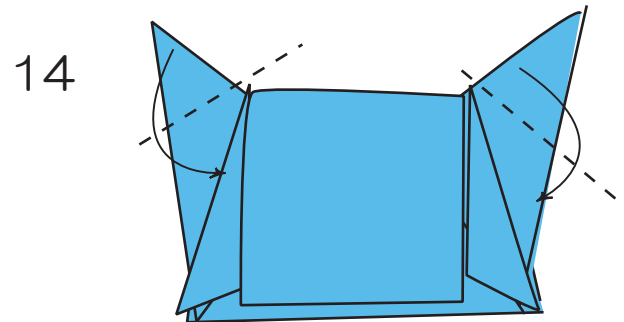

Draw the face.
Here is your Piggy face.
Make another 2 .
Have fun !

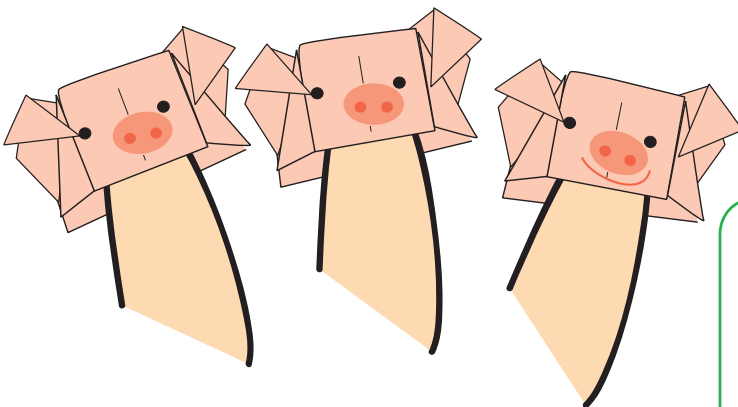

Idea:
When my daughter was little, she loved the book called 'This little piggy went to market'.