

# Shakespeare

Created by Shoko Aoyagi  
Diagrams by Shoko Aoyagi

©Shoko Aoyagi October 2006

おりがみ用紙 1枚

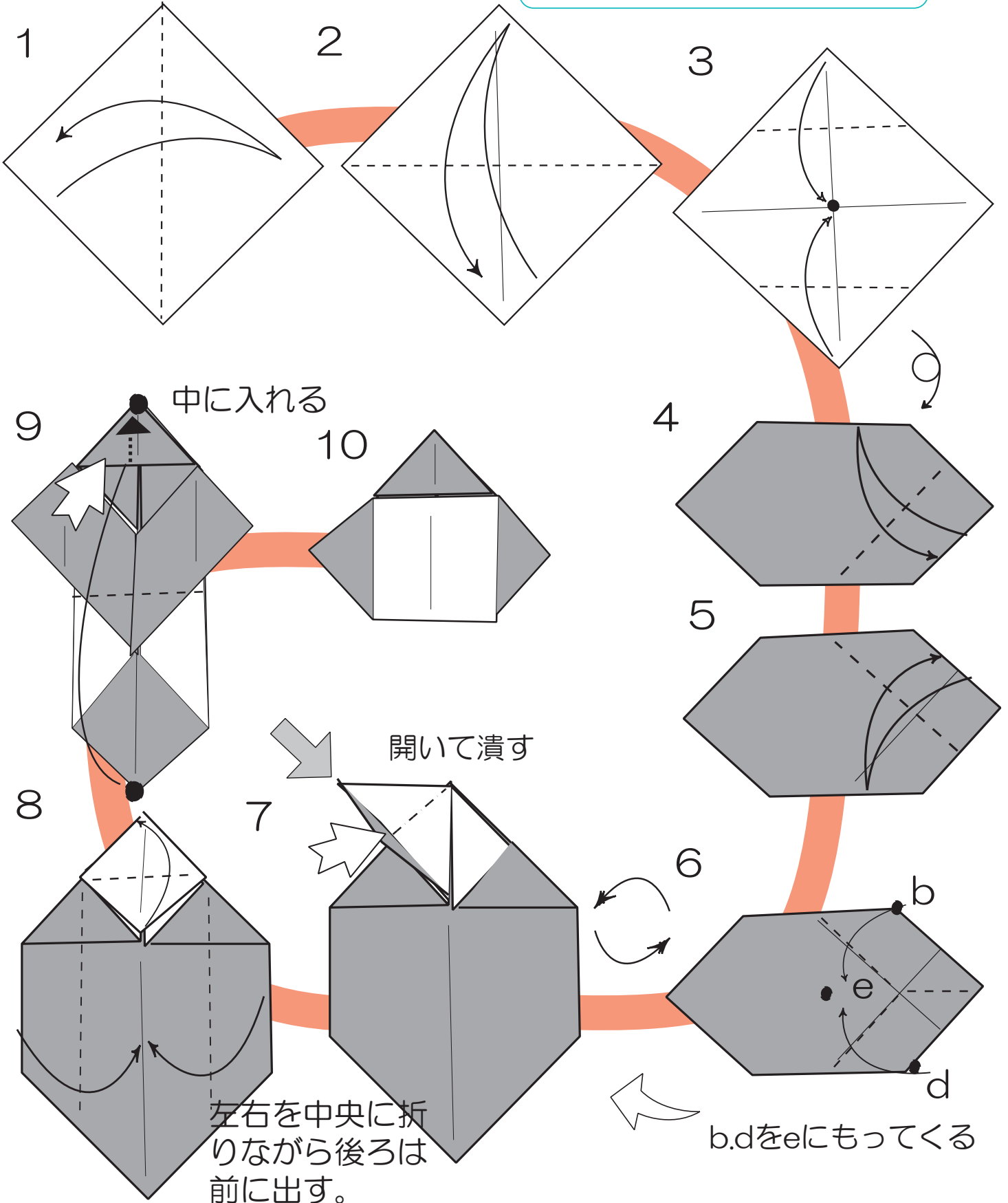
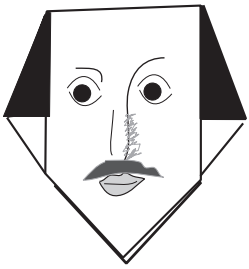

# William Shakespeare

Created by Shoko Aoyagi  
Diagrams by Shoko Aoyagi

©Shoko Aoyagi October 2006

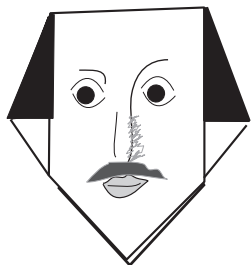

11

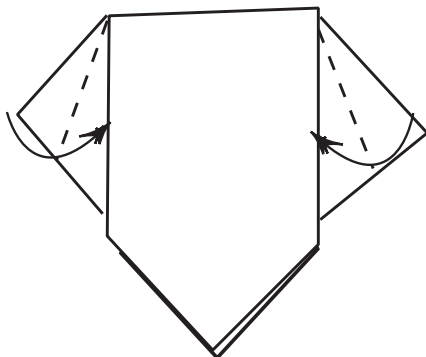

12

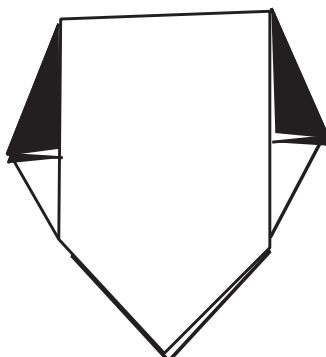

顔を描いてみよう！

13

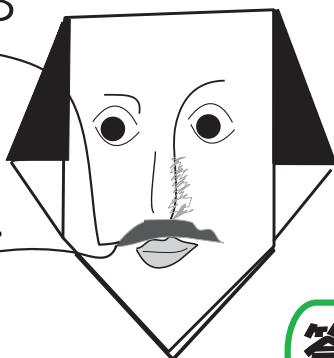

**To be, or not to be,  
that is the question.  
Who am I?**

日本語訳  
「生きるか、死ぬか、それが問題だ」  
私は誰でしょう？

**答: ウイリアム シェークスピア**  
1564-1616

11b

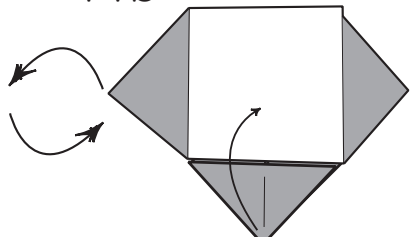

12b

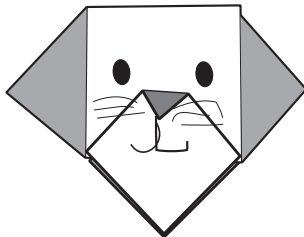

裏は犬にもなる。