

カンガルーのホルダー

©Shoko Aoyagi 2002

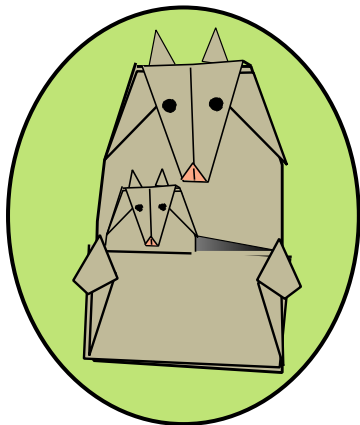

カラーのコピー用紙（灰色や、オレンジなど）
画用紙でも可。

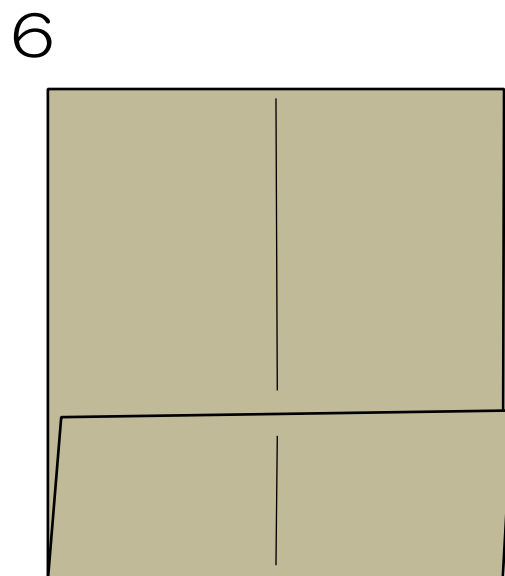
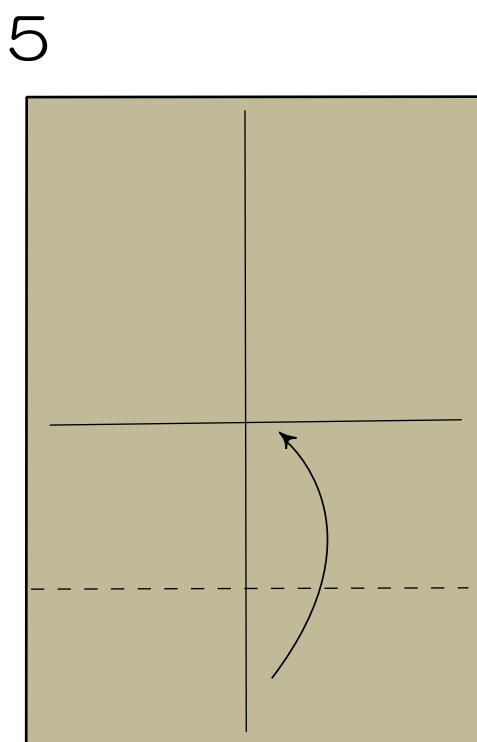
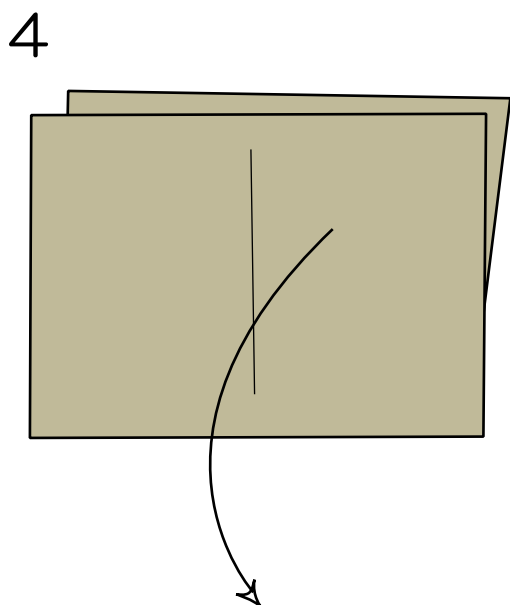
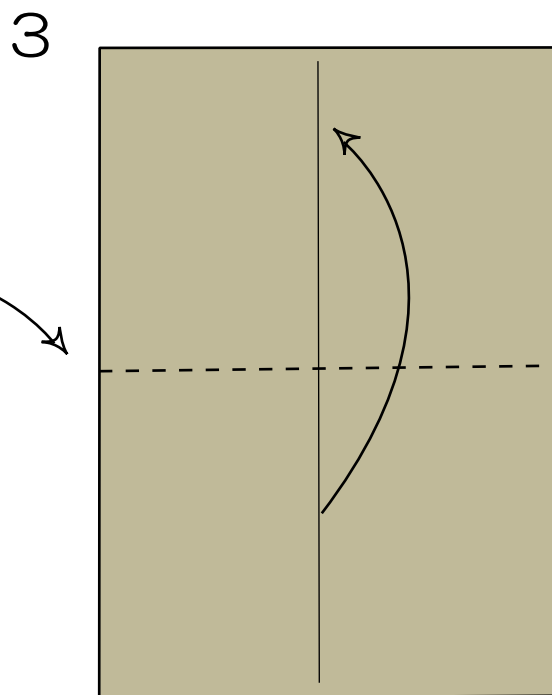
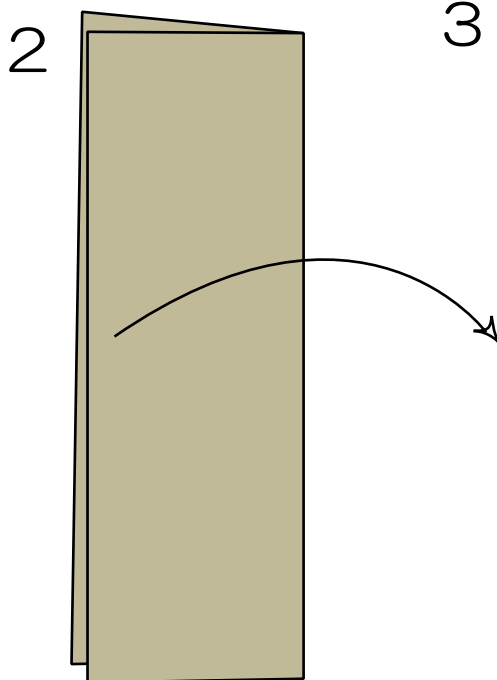
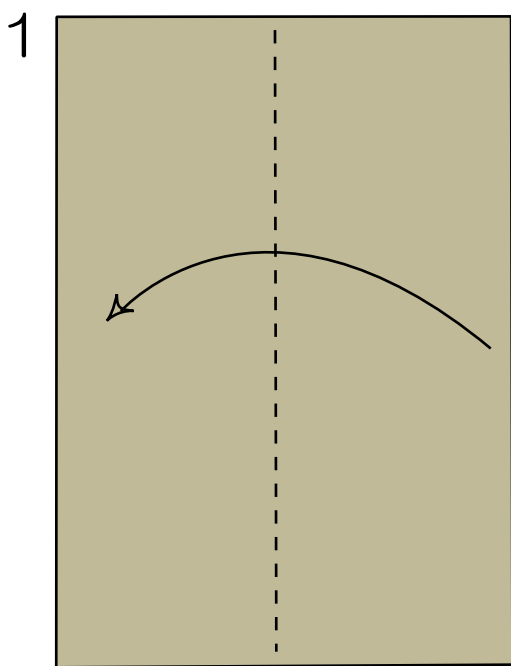

カンガルーのホルダー

©Shoko Aoyagi 2002

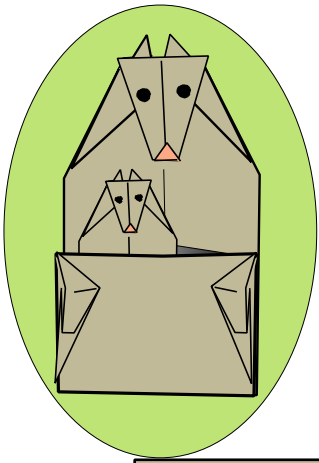

7

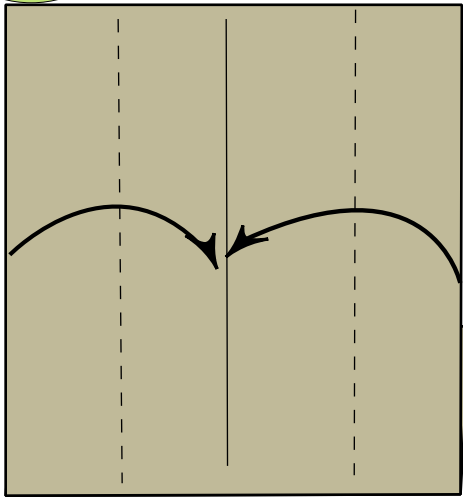

中央に折る

8

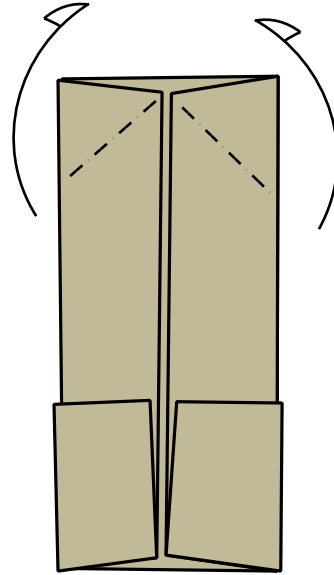

後ろに折る

9

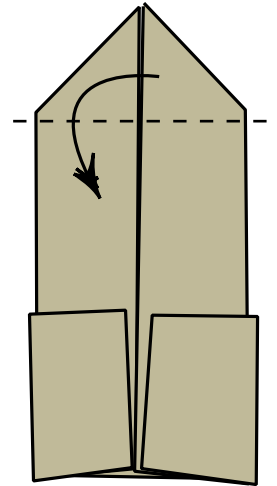

自分の方に折る

10

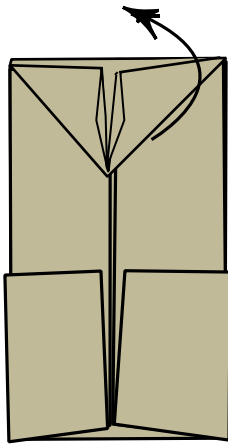

戻す

11

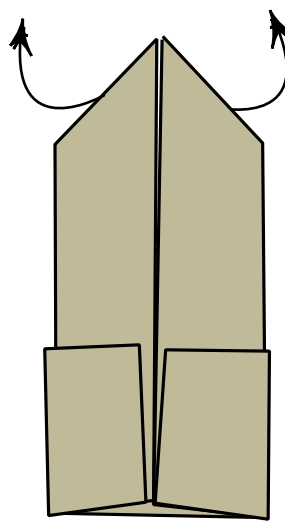

戻す

12

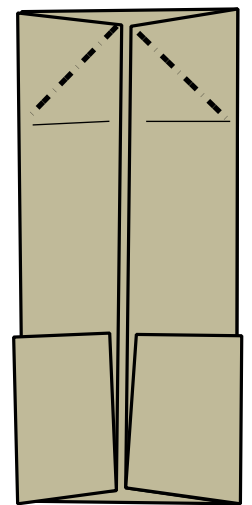

点線で山折

13

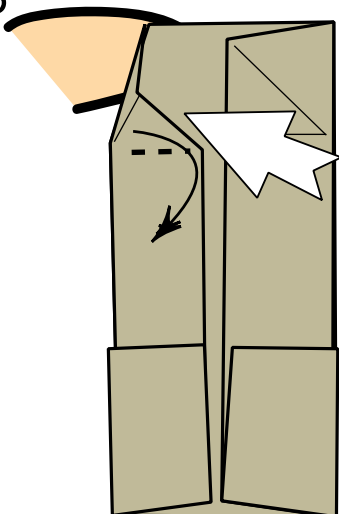

14

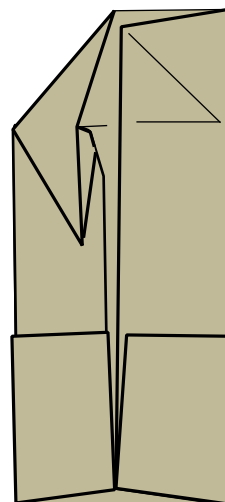

カンガルーのホルダー

3/5

©Shoko Aoyagi 2002

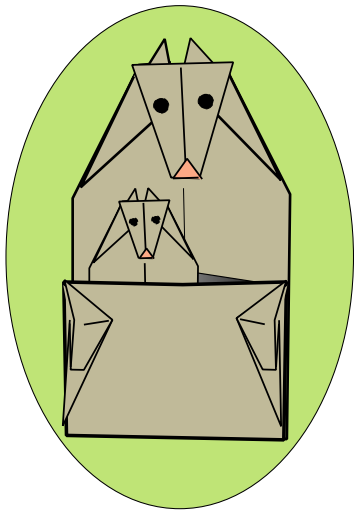

15

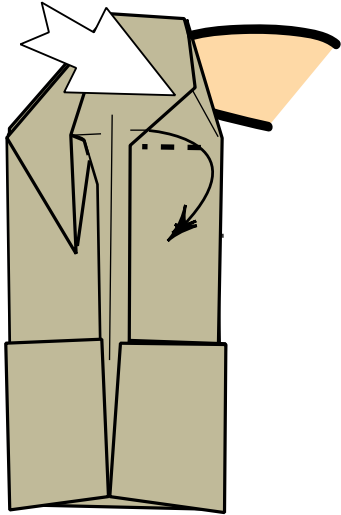

16

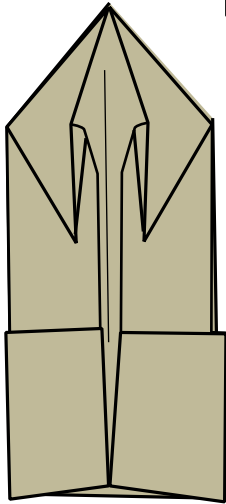

ひっくり返す 17

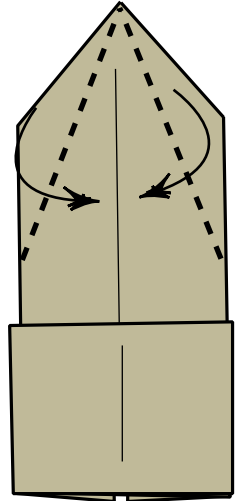
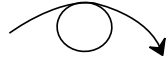

18

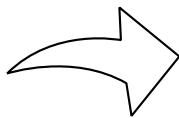
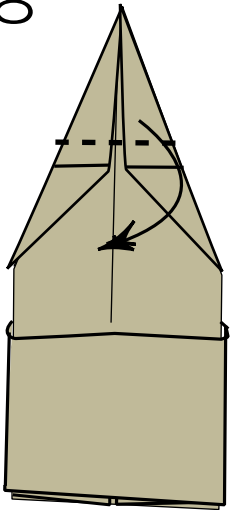

拡大

19

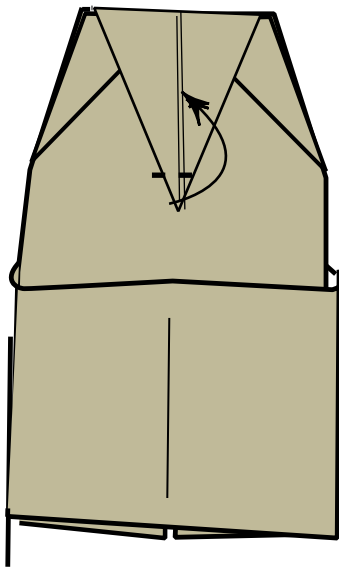

20

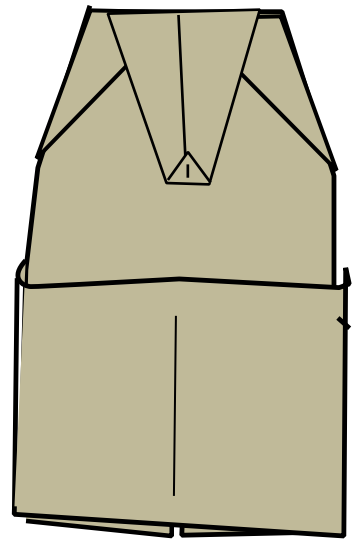

自分の方に折る

自分の方に折る

カンガルーの鼻
ができたよ。

カンガルーのホルダー

4/5

©Shoko Aoyagi

2002

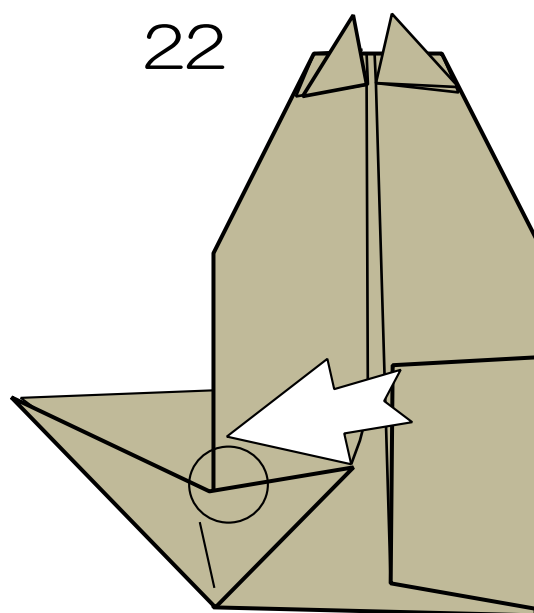
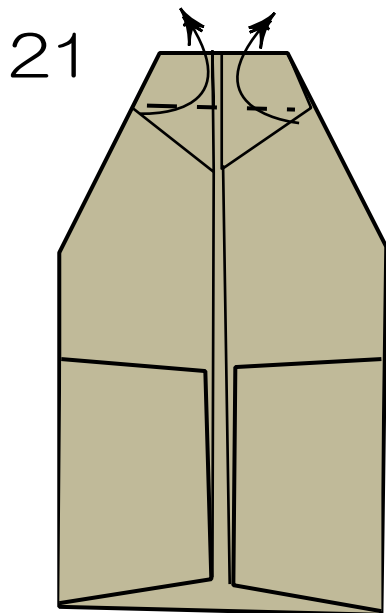
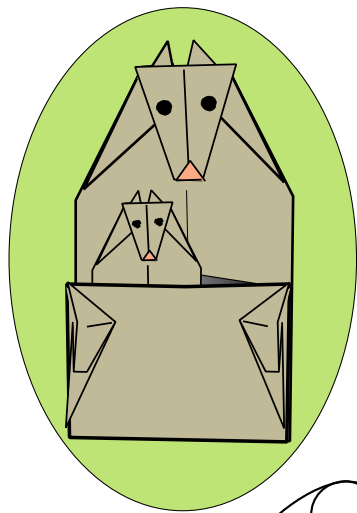

開いてつぶし折

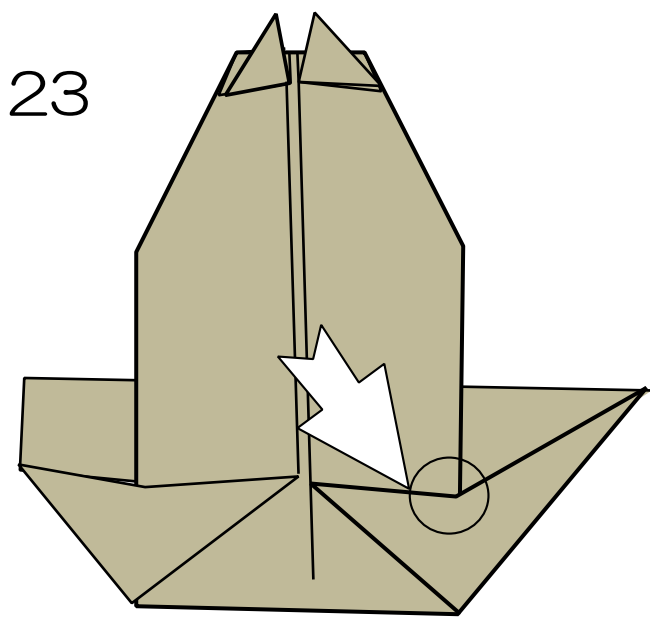

開いてつぶし折

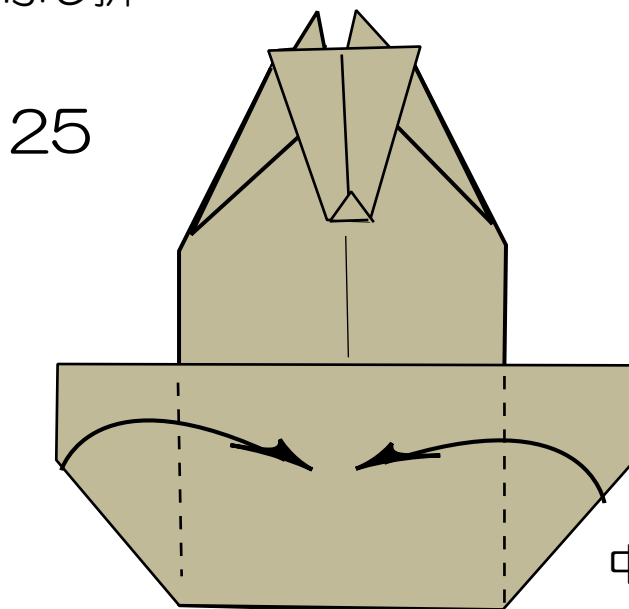
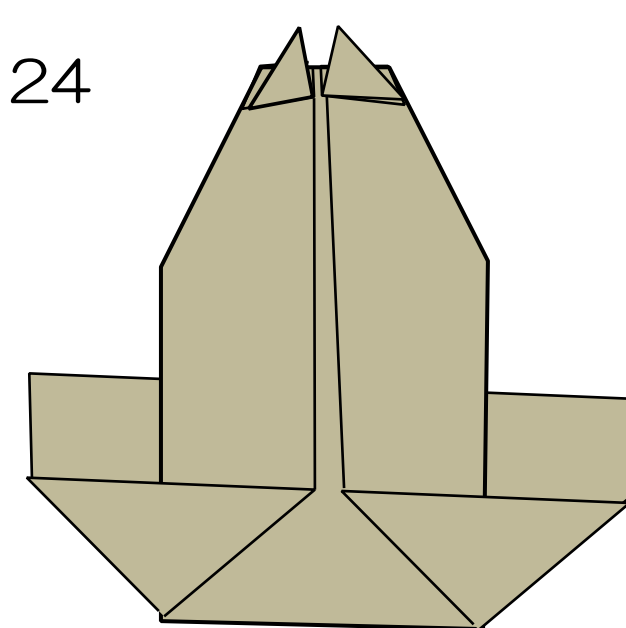

中央に折る

カンガルーのホルダー

©Shoko Aoyagi 2002

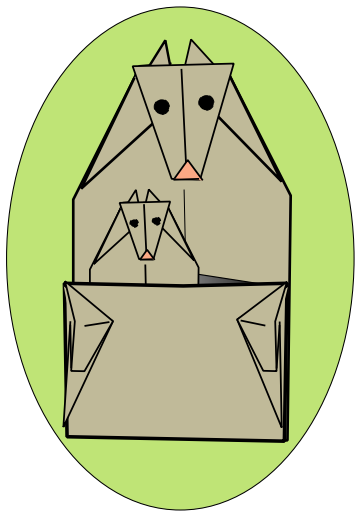

26

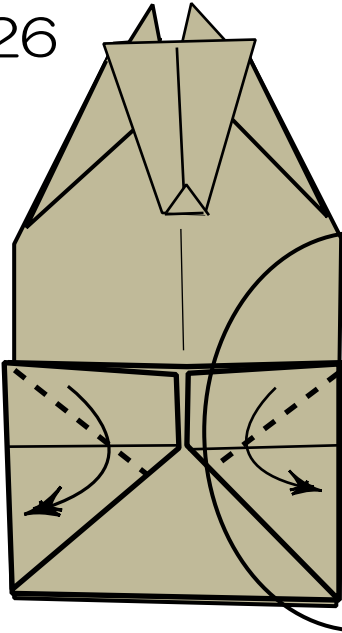

カンガルーのおてて（前足）
を作しましょう。

①～⑥までの折図に沿って折
りましょう。

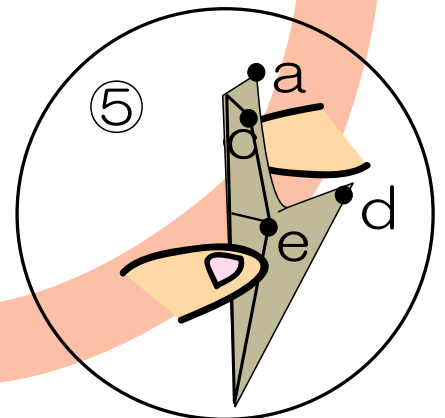
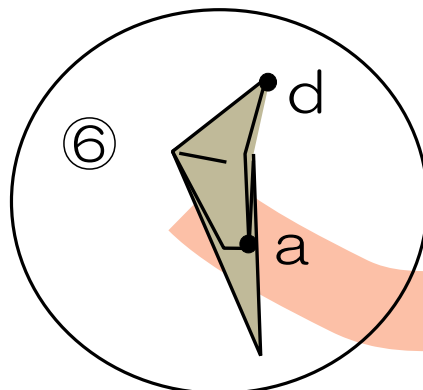
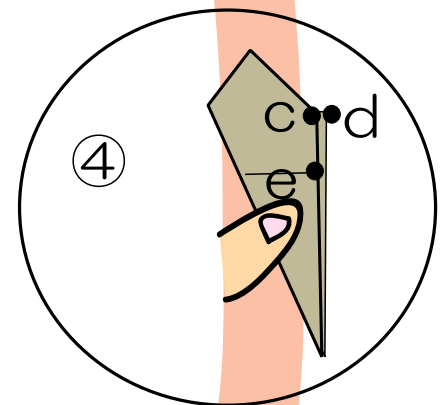
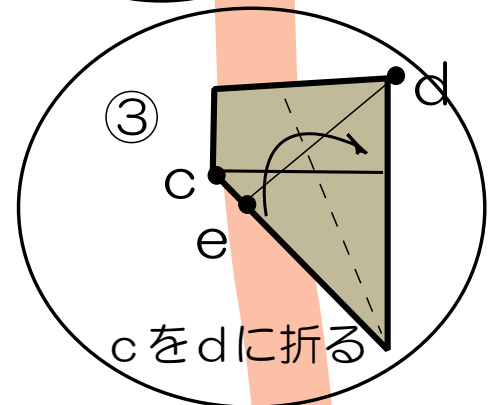
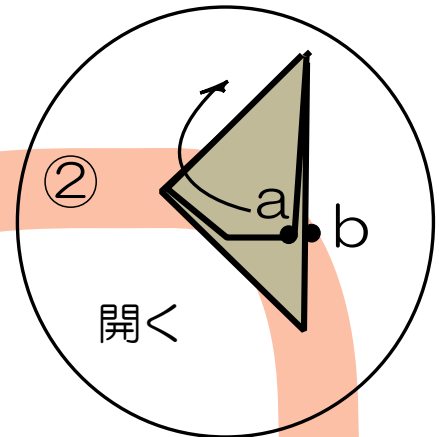
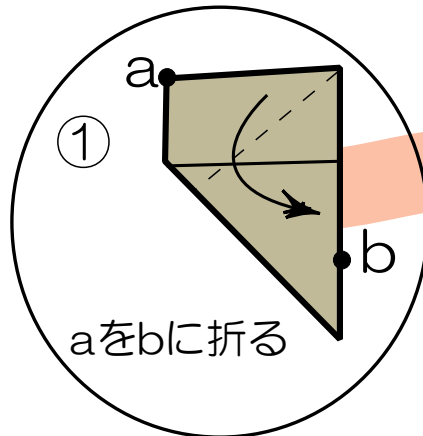
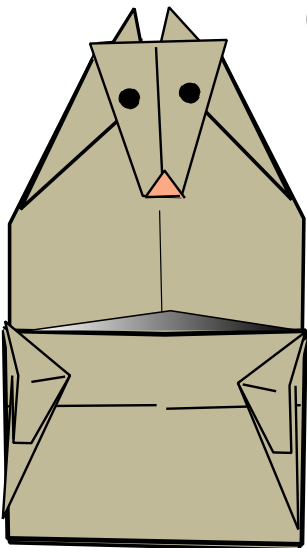

eの下を人差し指で
しっかり押さえて、
その先を下に持って
くる。折図⑥参照。

カンガルーのホルダーの出来上がり。
カンガルーと握手もできます。お知らせ
の紙をおなかに入れて図書館や
教室においてもいいね！