

からす

Created by Shoko Aoyagi
Diagram by Shoko Aoyagi

© Shoko Aoyagi August 2005

黒の折紙用紙 1枚

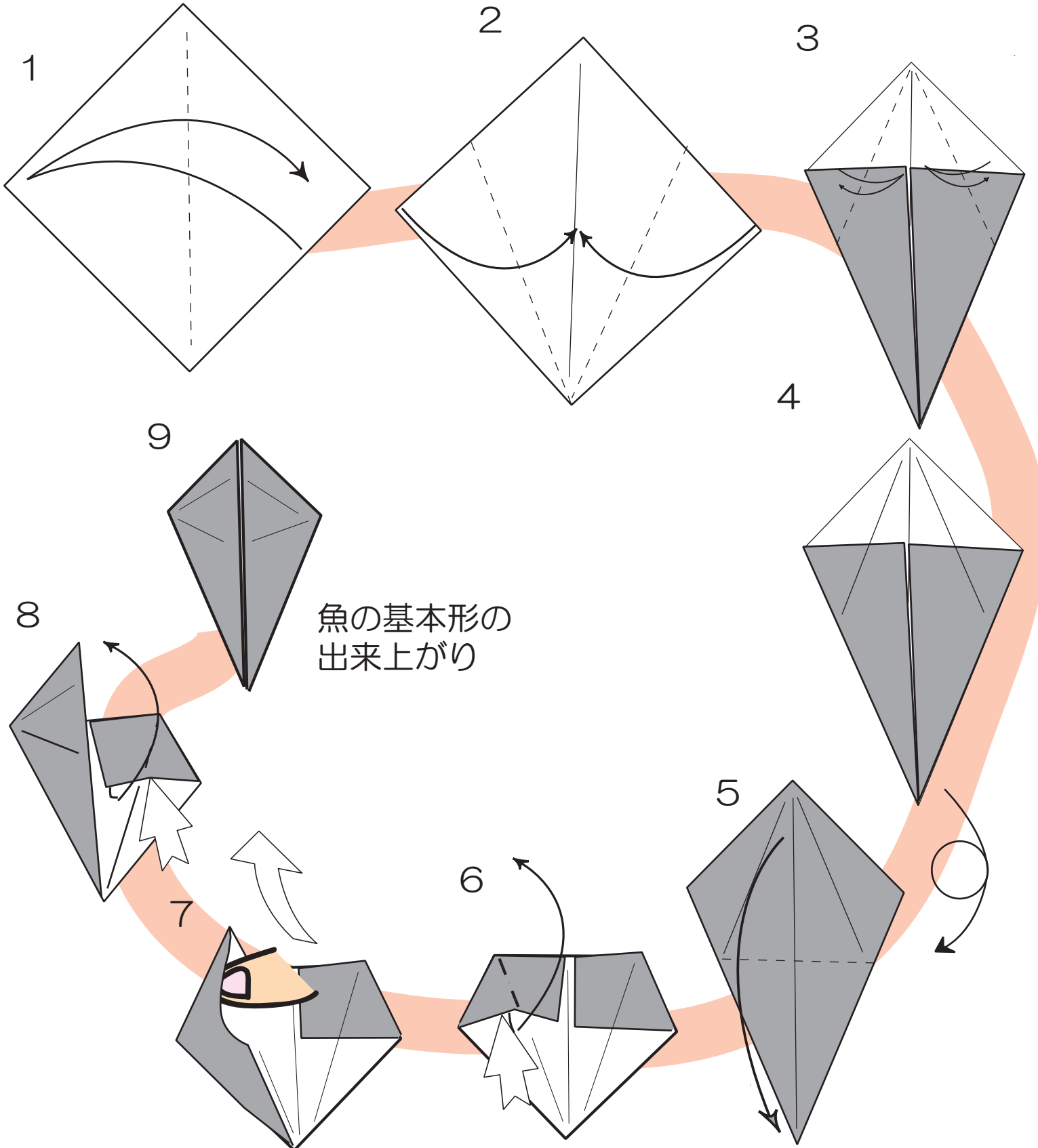
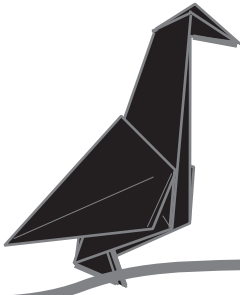

からす

Created by Shoko Aoyagi
Diagram by Shoko Aoyagi

© Shoko Aoyagi August 2005

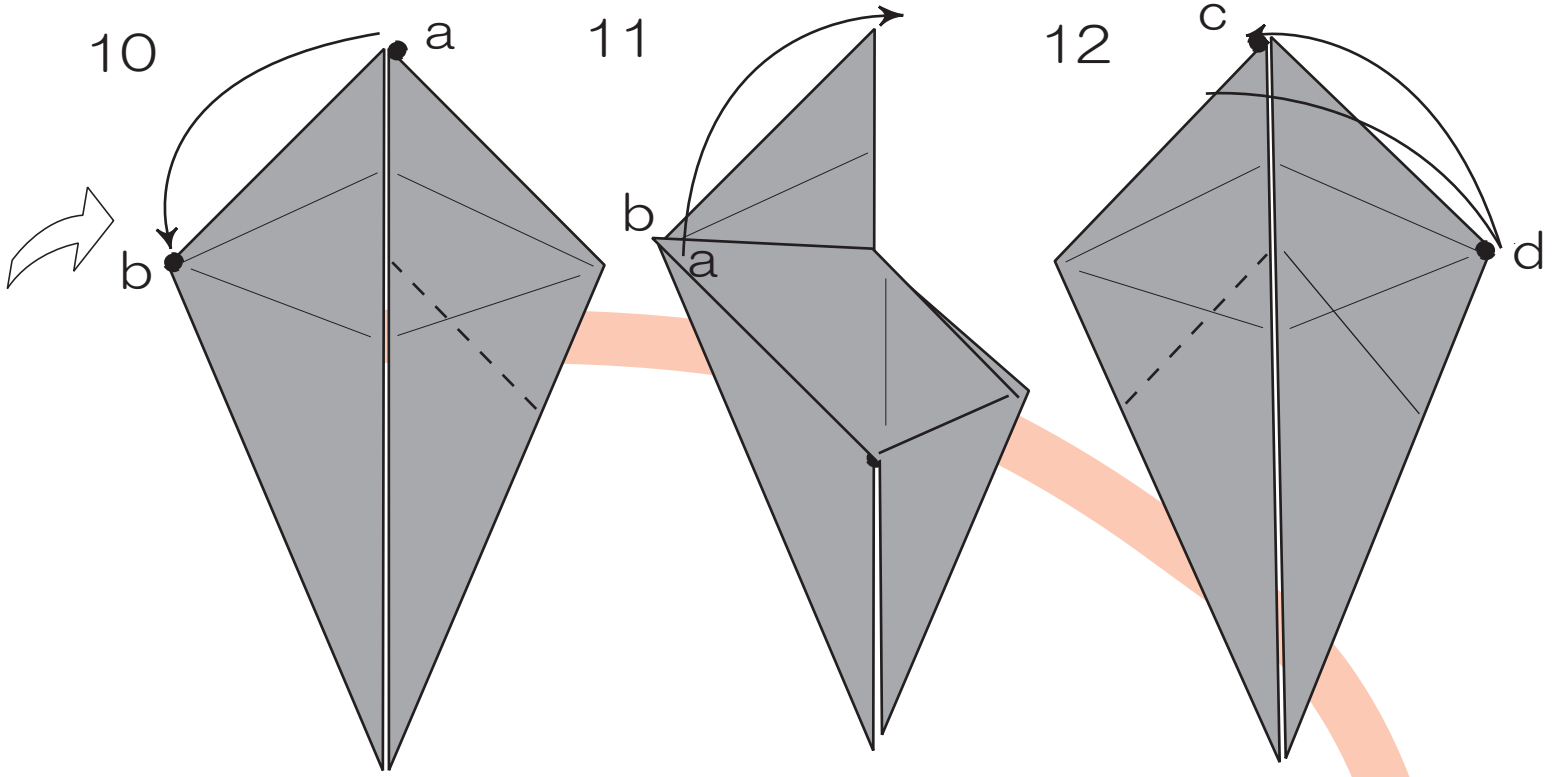
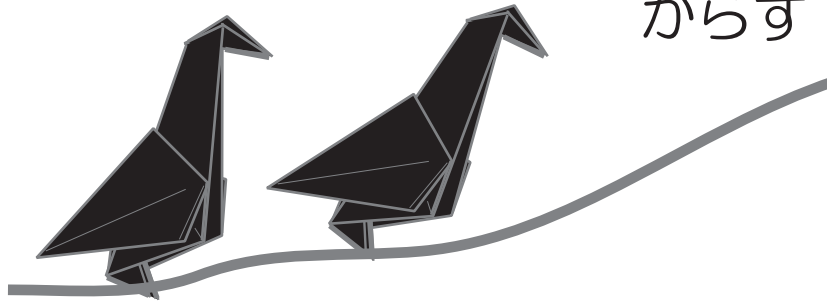

cdもabと同様に、
しっかり折り線をつけて戻す。

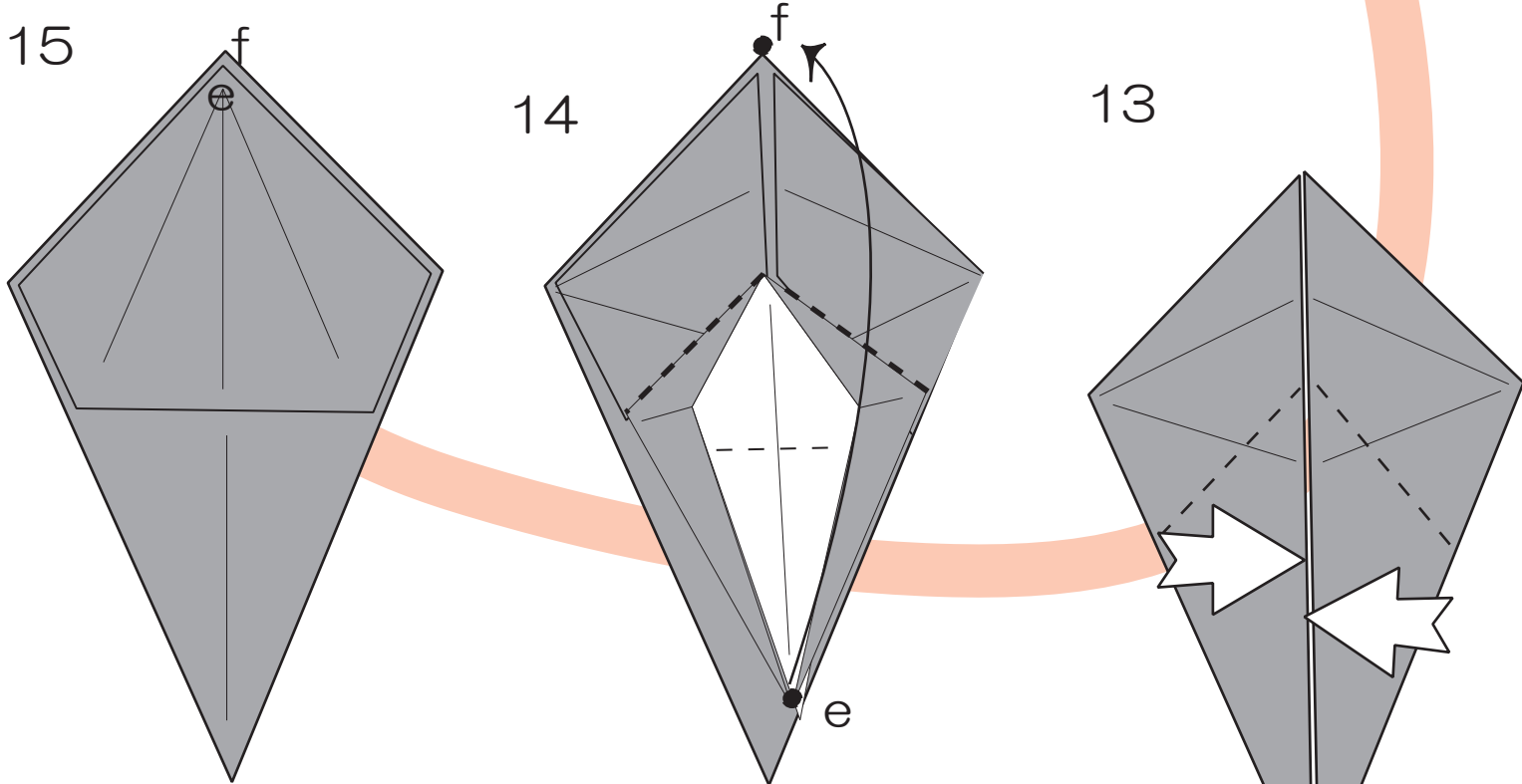

13でつけた折線を使って
5角形を作る。

からす

Created by Shoko Aoyagi
Diagram by Shoko Aoyagi

© Shoko Aoyagi August 2005

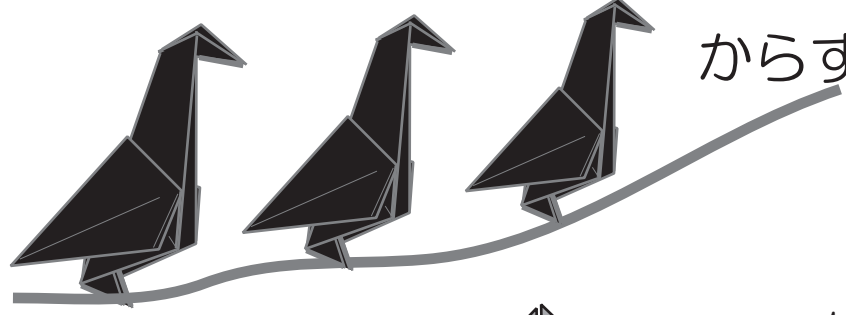

16

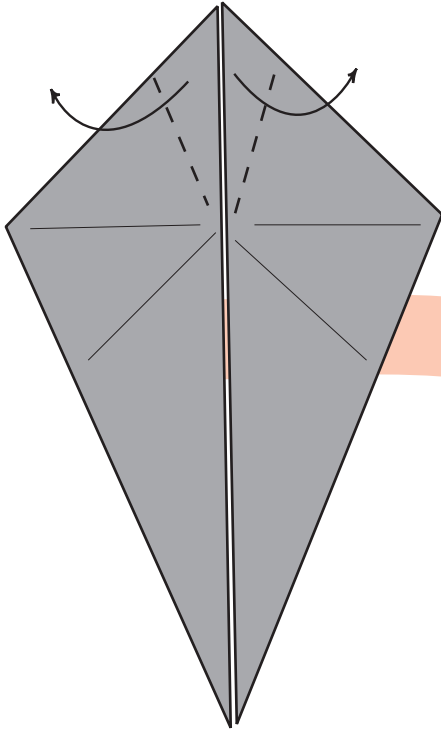

17

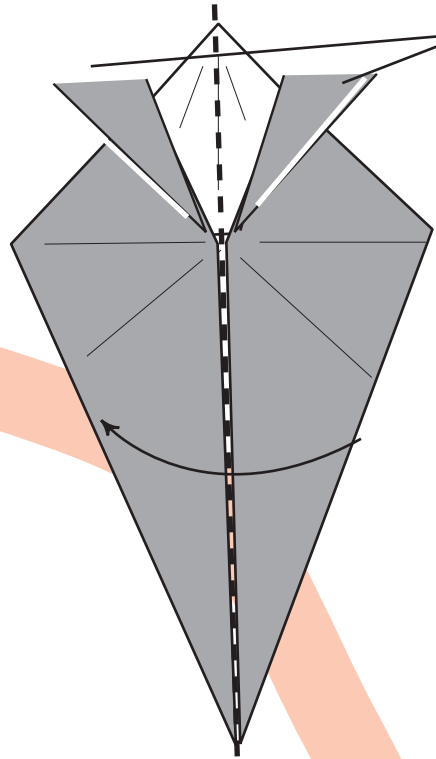

水平

上の部分が水平になる
ように折る

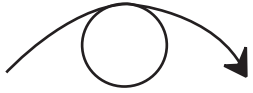

18

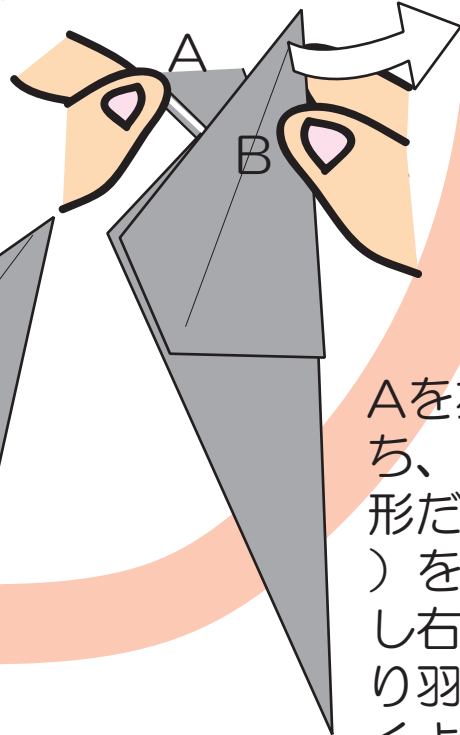

カラスの出来上がり

Aを左手で持
ち、B（5角
形だった部分
）を右手で少
し右に引っ張
り羽が落ちて
くように押さ
える。

20

19

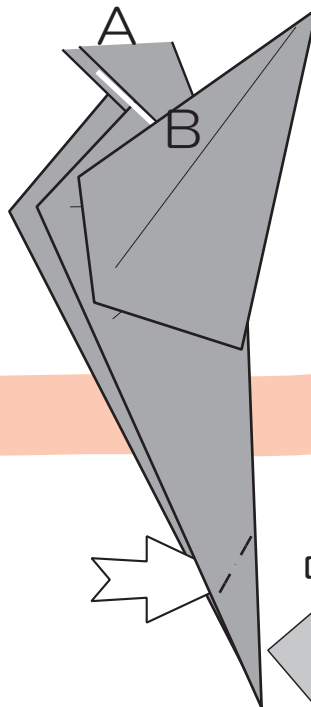

中割折

頭を作る

立ちますよ。

